

COMBITEK F 23 E

Installation and Servicing Instructions

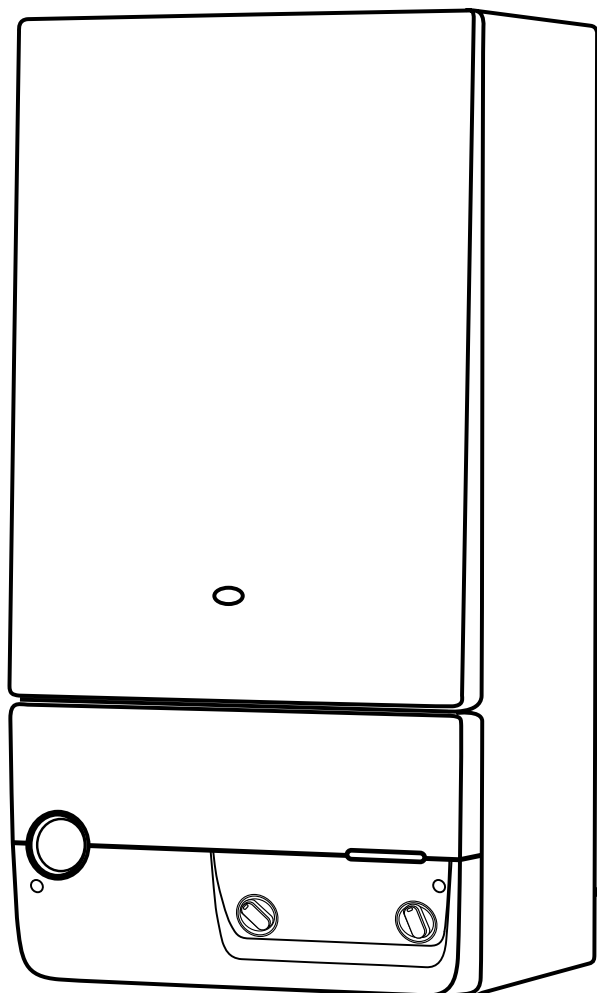

THIS IS A CAT II2H3+ APPLIANCE

IN WARRANTY

TECHNICAL HELPLINE

01773 828400

HEATCALL

01773 828100

Saunier Duval 

INSTALLATION AND SERVICING INSTRUCTIONS

COMBITEK F 23 E

Note: The boiler serial number is marked on the data label attached to the PCB housing behind the front lower section. Refer to the 'Introduction' section for a description of the basic functions of the boiler. The 'User' section describes how to safely operate the boiler.

Users' Instructions

Introduction	Page 2
Controls and lighting	3
Draining and filling	3
Heating safety valve	3
Servicing/maintenance	3
Cleaning	4
Boiler casing	4

Installation Instructions

Introduction	Page 4
Changing gas type	4
Technical data	4 - 5
Dimensions	5
Boiler schematic	6
Terminal positions	7

Heating and hot water system design	7
Boiler installation	8
Horizontal flue installation	9
Vertical flue installation	10
Electrical connection	11
Commissioning	12
Adjustments	13
Safety device	13
Setting	14

Servicing Instructions

Routine cleaning and inspection	Page 15
Replacement of parts	16 - 21
Schematic wiring diagram	22
Fault finding	23 - 24
Spare sparts	24



Mandatory warning for CE countries

WARNING, these appliances were designed, approved and inspected to meet the requirements of the English market. The identification plate located on the inside of the appliance **certifies the origin** where the product was manufactured and the **country** for which it is intended.

If you see any exception to this rule, please contact your nearest stockist.

Thank you in advance for your assistance.

USER INSTRUCTIONS

INTRODUCTION

The **Combitek F 23 E** is a wall mounted combination boiler providing central heating and instantaneous domestic hot water.

These instructions should be carefully followed for the safe and economical use of your boiler.

Gas leak or fault

If a gas leak or fault exists or is suspected, turn the boiler and gas supply off and consult the local gas company or your Installer/Service provider.

In case of power supply failure

The boiler no longer operates.

As soon as power supply is restored, the boiler will restart automatically.

In case of loss of water in the system

CAUTION. The boiler is installed as part of a sealed system which must only be drained and filled by a competent person.

If the pressure shown on the pressure gauge is less than 1.5 bar the system must be filled up.

Important notice: A central heating system cannot operate satisfactorily unless it is properly filled with water and unless the air initially contained in the piping systems has been properly bled off. If these conditions are not satisfied, air noise will occur within the system and the boiler may fail to operate.

Air in the heating system

Persistent air in the heating system may indicate leaks in the system or corrosion taking place. Call your Installer/Service provider.

Overheating safety

In the event of problem, the overheat safety device causes safety shutdown of the boiler. If this happens, call your Installer/Service provider.

USER INSTRUCTIONS

The control panel is located on the front bottom section. The controls on this panel allow the boiler to be started, shut down and controlled during use.

- 1 - Pressure / Temperature gauge
- 2 - Hot water / Heating temperature control & summer / winter switch
- 3 - Timeclock
- 4 - Mains On/Off switch

Diagram 1

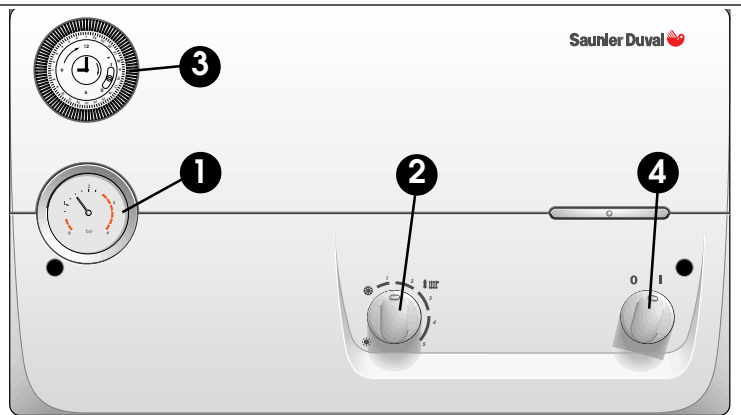

CONTROLS AND LIGHTING

Make sure that:

The boiler is connected to the electrical supply.
The boiler gas service cock is open.
The pressure gauge reads between 1.5 and 2 bar.
The boiler is now ready to start.

To start the boiler

Switch on using mains switch (4), see diagram 1.
Place switch (2) in the Summer or Winter position

To stop the boiler

Place switch (4) to the Off position (0).

Setting to 'Summer' mode (Hot water only)

Place switch (2) in the Summer position (see diagram 2).



Setting to 'Winter' mode (Heating and hot water)

Place switch (2) to the Winter position

Adjust the heating temperature control (2) to the desired temperature.

The heating will operate according to the requirements of the timeclock and/or room thermostat if fitted or, will operate according to the system requirements.

Domestic hot water always has priority over central heating.

Timeclock

To set the clock rotate actuator mechanism clockwise, by hand, until current time is indicated.

See diagram 3.

Note: The time is set in 24 hour format, for example 1300pm for 1pm

Setting the programme 'on & off' times

Select the **on** times by pushing the black tappets to the outside

Select the **off** times by pushing the black tappets to the inside

The clock shown in diagram 3 is set as follows

- On** 07.00am to 09.00am
- Off** 09.00am to 4.00pm
- On** 4.00pm to 10.00pm
- Off** 10.00pm to 07.00am

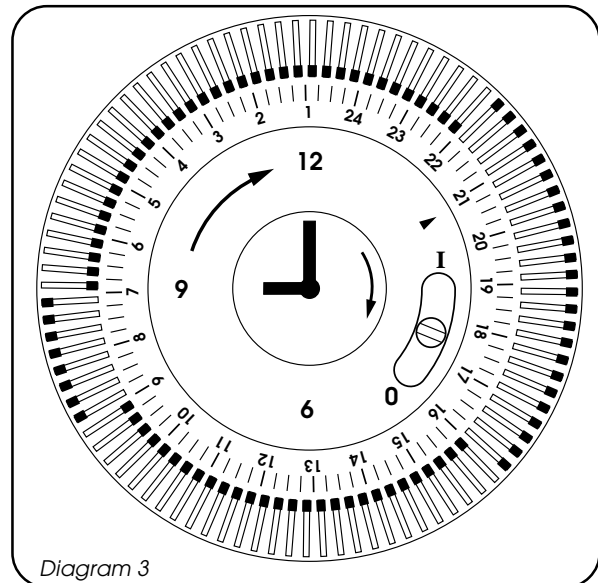

Diagram 3

To override or advance the clock

The clock has a manual on/off switch see diagram 3 which operates as follows:

- Upper position 1** Heating on continuously
- Middle position 0** Heating on timed
- Lower position I** Heating off

DRAINING AND FILLING

Caution: The boiler is installed as part of a sealed system which must only be drained and filled by a competent person.

Note: If there is persistent loss of system pressure, you must consult your Installer/Service Provider.

HEATING SAFETY VALVE

CAUTION: A safety valve with a discharge pipe is fitted to this boiler.

The valve **MUST NOT BE TOUCHED** except by a competent person. If the valve discharges at any time, switch the boiler off and isolate it from the electrical supply. Contact your Installer/Service Provider.

SERVICING/MAINTENANCE

To ensure the continued efficient and safe operation of the boiler, it is recommended that it is checked and serviced at regular intervals. The frequency of servicing will depend upon the installation conditions and usage but, in general, once a year should be enough.

USER INSTRUCTIONS

CLEANING

The boiler casing can be cleaned with a damp cloth followed by a dry cloth to polish.
Do not use abrasive or solvent cleaners.

BOILER CASING

CAUTION: Do not remove or adjust the casing in any way, as incorrect fitting may result in faulty operation. If in doubt, contact your Installer/Service Provider.

INSTALLATION INSTRUCTIONS

INTRODUCTION

The **Combitek F 23 E** is a wall mounted combination boiler providing central heating and instantaneous domestic hot water.

Note: this boiler requires no fixing jig and has top outlet flueing only (there is no rear flue option).

The boiler is of the **II2H3+** category for use with **Natural gas (G20)**. To convert to **Butane (G30)** or **propane (G31)**, the following kit is required.
Gas conversion kit :part number 86161

The boiler has a fan assisted, balanced, flue which both discharges the product of combustion to, and draws the combustion air from, the outside of the building.

Accessories

A range of accessories are available including, vertical flue components. For further information, contact you nearest stockist.

Gas Safety (Installation and Use) Regulations

In the interests of gas safety, it is the law that ALL gas appliances are installed and serviced in by a competent person in accordance with the above regulations.

Gas leak or fault

If a gas leak or fault exists or is suspected, turn off the boiler and gas supply and consult the local gas company or your Installer/Service Provider.

TECHNICAL DATA

Heating output

automatically variable from	8,9 kW to 23,3 kW 30,000 BTU/H to 80,000 BTU/H
Efficiency	82,4 %
Heating adjustment	38°C to 90°C
Expansion vessel effective capacity	6,5 l
Expansion vessel charge pressure	0,5 bar
Maximum system capacity at 75°C	140 l
Safety valve, maximum service pressure	3 bar
Products outlet diameter	60 mm
Fresh air inlet diameter	100 mm

Hot water output

automatically variable from	8,9 kW to 23,3 kW 30,000 BTU/H to 80,000 BTU/H
Maximum hot water temperature	65 °C
Specific flow rate (for 35°C temp rise)	9,6 l/min
Threshold flow rate	3 l/min
Nominal water flow rate	12 l/min
Maximum supply pressure	10 bar
Minimum operating pressure	0,5 bar
Electrical supply	230 V
Maximum absorbed power	130 W

	Natural Gas (G20)	Butane (G30)	Propane (G31)	Town gas (G130)
Burner injector	1,2 mm	0,73 mm	0,73 mm	2,4 mm
Inlet pressure	20 mbar	29 mbar	37 mbar	8 mbar
Gas rate (maximum)	2,70 m³/h	2,01 kg/h	1,98 kg/h	3,88 m³/h
Gas rate (minimum)	1,13 m³/h	0,84 kg/h	0,74 kg/h	1,63 m³/h

		Heat output														
(kW)		8,9	10	11	12	13	14	15	16	17	18	19	20	21	22	23,3
(Btu/h)		30387	34142	37557	40971	44385	47799	51214	54628	58042	61456	64871	68285	71699	75113	79552

		Heat input														
(kW)		11,9	13,2	14,4	15,7	16,9	18,1	19,2	20,4	21,5	22,7	23,8	24,9	26,0	26,9	28,3
(Btu/h)		40678	45130	49332	53481	57579	61627	65626	69575	73477	77333	81142	84906	88913	91713	96602

GAS																
G 20	(mbar)	1,3	2,1	2,6	3,0	3,5	4,0	4,5	5,1	5,7	6,3	6,9	7,6	8,3	8,8	9,8
G 30	(mbar)	3,7	5,3	6,3	7,4	8,6	9,8	11,1	12,5	13,9	15,4	17,0	18,6	20,4	21,7	24,1
G 31	(mbar)	4,0	6,3	7,5	8,8	10,2	11,7	13,3	14,9	16,7	18,5	20,3	22,2	24,4	26,0	28,8

INSTALLATION INSTRUCTIONS

Pump:

The performance of the pump varies according to the pump bypass setting, see diagram 3.

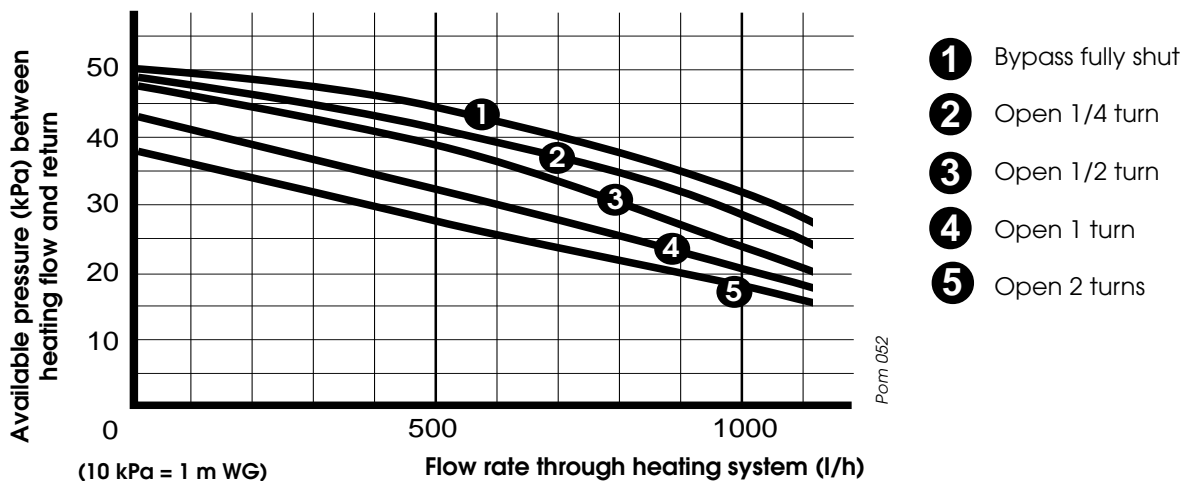

Diagram 3

DIMENSIONS

The boiler is delivered in two separate packages:

- The boiler
- The flue system

Clearances

The boiler can be installed with the following clearances:
 50 mm either side of the boiler
 600 mm to the front of the boiler
 300 mm below the boiler

Net weight: 41 kg
 Gross weight: 43 kg

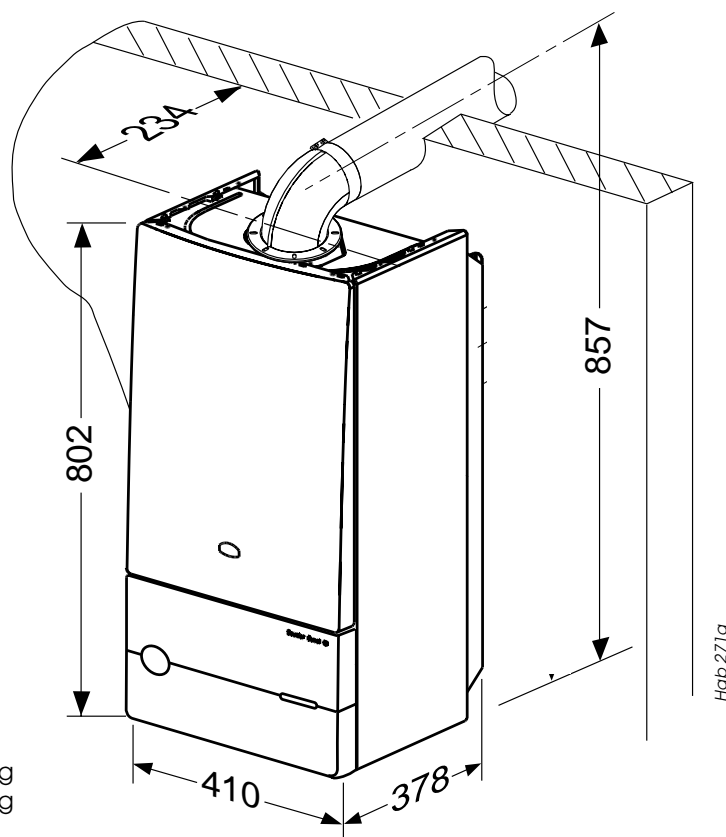

Diagram 4

INSTALLATION INSTRUCTIONS

BOILER SCHEMATIC

- | | |
|---------------------------------------|------------------------------------|
| 3 - Ignition module | 19 - Overheat thermostat |
| 4 - Heating temperature adjuster | 20 - Flame sense electrode |
| 6 - Pressure gauge | 21 - Loss of water pressure switch |
| 7 - non-return valve | 22 - Fan |
| 8 - Expansion vessel | 23 - Air pressure switch |
| 9 - Pump | 24 - Gas cock |
| 10 - Automatic air vent | |
| 11 - Burner | |
| 12 - Burner pressure test point | A - Heating return |
| 13 - Heat exchanger | B - Cold water inlet |
| 14 - Gas valve | C - Heating flow |
| 16 - Heating and hot water thermistor | D - Domestic hot water flow |
| 17 - Ignition electrode | E - Gas supply |

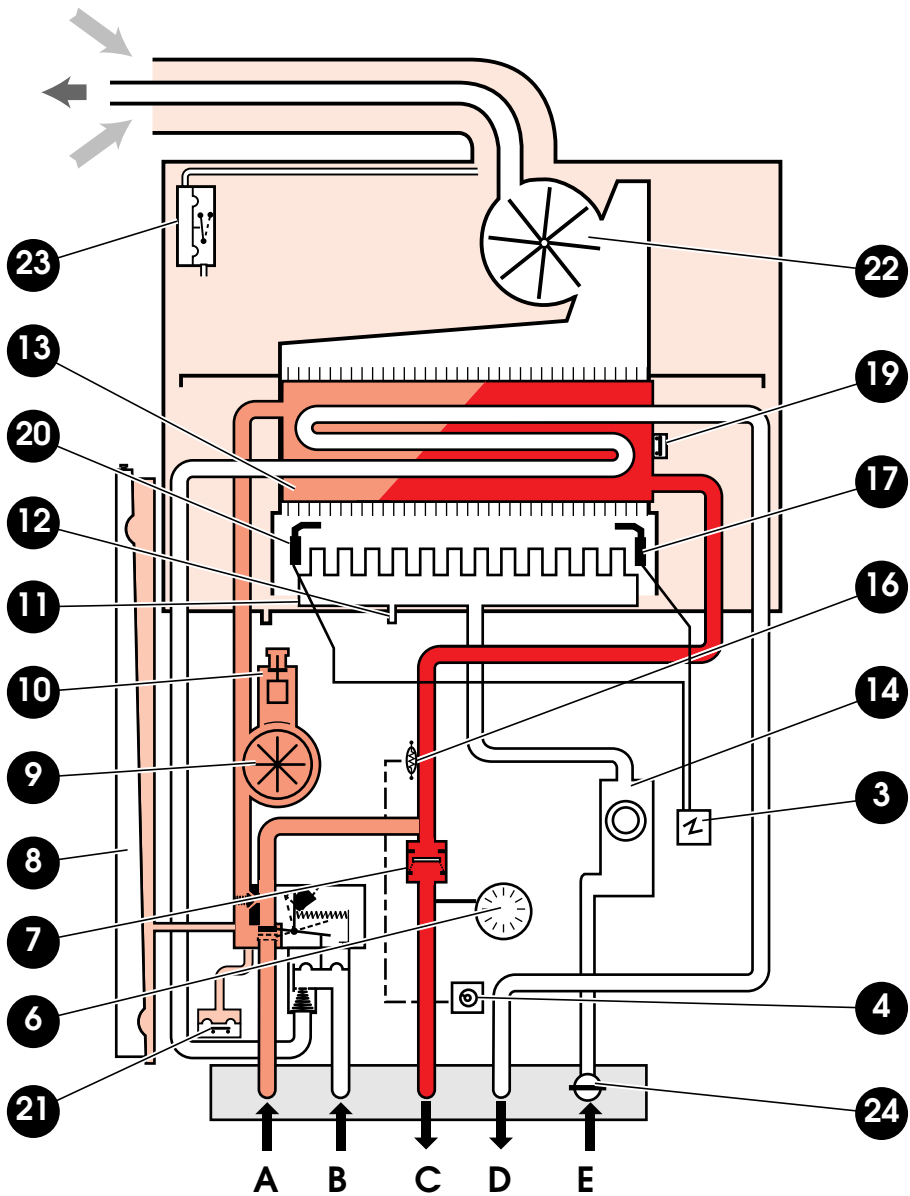

Diagram 5

Shy 131b

INSTALLATION INSTRUCTIONS

Minimum dimensions (in mm) for the positioning of flue terminals

A - Under a window	300
B - Under an air vent	300
C - Under a gutter	75
D - Under a balcony	300
E - From an adjacent window	300
F - From an adjacent air vent	300
G - From vertical drain pipes or soil pipes	75
H - From an external corner of the building	300
I - From an internal corner of the building	300
L - From the ground or from another floor	300
M - Between two terminals vertically	1500
N - Between two terminals horizontally	300

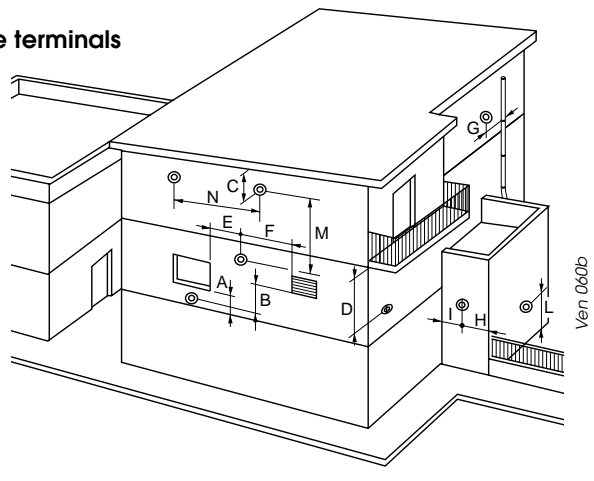

Diagram 6

TERMINAL POSITIONS

The minimum acceptable spacings from the terminal to obstructions and ventilation openings are shown in diagram 6 :

Cupboard or compartment ventilation

The boiler can be fitted in a cupboard or compartment without the need for additional permanent high and low level ventilation

HEATING SYSTEM DESIGN

The **combitek F 23 E** is compatible with any type of sealed system installation, i.e. radiators, fan convectors etc.

Pipe sectional areas shall be determined in accordance with normal practices, using the pump curve, refer to '**Technical Data**'. The distribution system shall be calculated in accordance with the output requirements of the actual system, not the maximum output of the boiler. However, provision shall be made to ensure sufficient flow so that the temperature difference between the flow and return pipes is less than or equal to 20°C. The minimum flow is **500 l/h**.

The piping system shall be routed so as to avoid any air pockets and facilitate permanent venting of the installation. Bleed fittings shall be provided at every high point of the system and on all radiators.

The total volume of water permitted for the heating system depends, amongst other things, on the static head in the cold condition. The expansion vessel on the boiler is pressurised at 0,5 bar (corresponding to a static head of 5m wg.) and allows a maximum system volume of 140 litres for an average temperature of 75°C and a maximum service pressure of 3 bar. This pressure setting can be modified at commissioning stage if the static head differs.

Provision shall be made for a drain valve at the lowest point of the system.

Thermostatic radiator valves are permitted.

A suitable WRC approved **filling loop must be fitted** to enable correct filling of the system.

In all cases, it is **ESSENTIAL** that the system be thoroughly flushed prior to installing the new boiler.

DOMESTIC HOT WATER SYSTEM DESIGN

Copper tubing must be used for the domestic hot water system. Unnecessary pressure losses should be avoided.

The domestic hot water supply pressure must be between 0.5 and 10 bar. If the pressure exceeds 3 bar, a pressure reducing valve must be fitted.

Hard water areas

In areas where the water hardness exceeds 200 mg/litre, it is recommended that a suitable scale reducing device is fitted.

Heating system connections - Pipe Ø 22 mm.

Hot water system connections - Pipe Ø 15 mm.

Gas connection - Pipe Ø 22mm.

Safety valve discharge

WARNING: It must not discharge above an entrance or window or any type of public access area.

Connect the safety valve discharge pipe to the valve, the discharge must be extended using not less than 15 mm o.d. pipe, to discharge in a visible position outside the building, facing downward, preferably over a drain. The pipe must have a continuous fall and be routed to a position so that any discharge of water, possibly boiling or steam, cannot create any danger to persons, damage to property or external electrical components and wiring. Tighten all pipe connection joints.

Gas connection

The supply from the governed meter must be of adequate size to provide a constant inlet working pressure of 20 mbar (8 in wg).

To avoid low pressure problems, it is recommended that the supply is taken to the boiler using 22 mm pipe as far as possible.

On completion, the gas installation must be tested using the pressure drop method and purged in accordance with the current issue of BS6891.

Gas Safety (Installation and Use) Regulations.

In your interests and that of gas safety, it is the law that **ALL** gas appliances are installed and serviced by a competent person in accordance with the above regulations.

INSTALLATION INSTRUCTIONS

Boiler connections

- A** Heating return
- B** Cold water mains inlet
- C** Heating flow
- D** Hot water outlet
- E** Gas connection
- F** Safety valve discharge connection

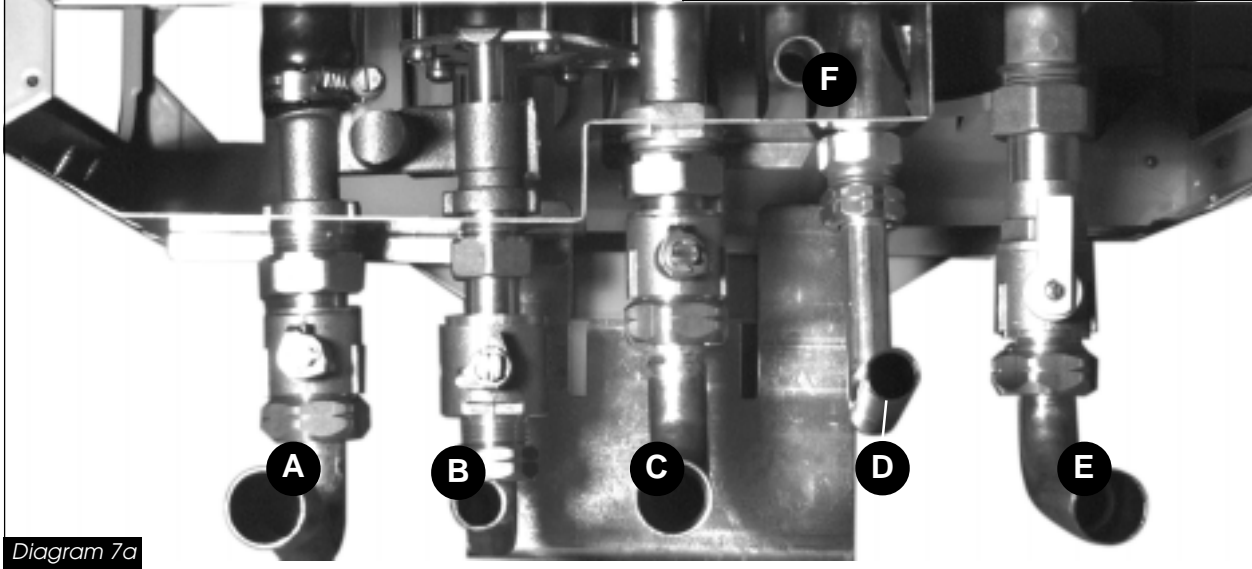
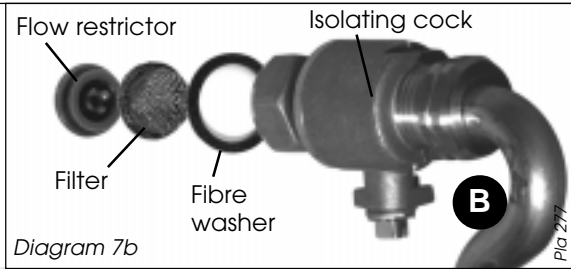

Statutory requirements

The installation of this boiler must be carried out by a competent person in accordance with the relevant requirements of the current issue of:

- The Gas Safety (Installation and Use) Regulations
- The Building Regulations
- The local water company Bylaws
- The Building Standards Regulations (Scotland)
- The Health and Safety at Work Act

Sheet metal parts

WARNING: When installing or servicing this boiler, care should be taken when handling the edges of

sheet metal parts to avoid the possibility of personal injury.

Installing the boiler

Prior to installing the boiler, the system must be thoroughly flushed to eliminate any foreign bodies and contaminants such as filings, solder, particles, oil, grease etc.

Note: Solvent products could cause damage to the system.

BOILER INSTALLATION

To install the boiler, proceed as follows:

- Allowing sufficient clearances for servicing/repair, place the template on the wall. Determine the position of the flue hole and drill hole for flue, preferably using a 120 mm core drill.
- Drill two holes for the hanging bracket. Plug and screw to wall.
- Fasten lower spacing brackets to boiler (see template)
- Remove template.
- Hang the boiler on the hanging bracket.

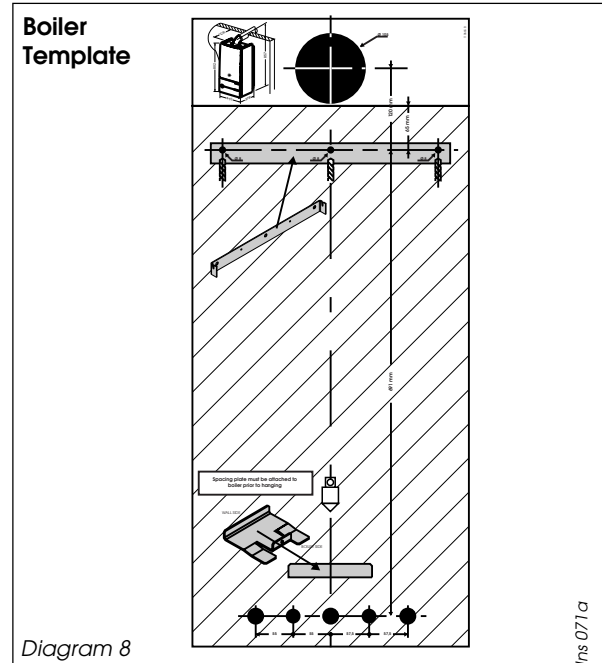

INSTALLATION INSTRUCTIONS

HORIZONTAL FLUE INSTALLATION

- Fit gasket (H) onto underside of elbow (C)
- Carefully insert 'o' rings (J) into upper and lower parts of inner elbow
- Fit elbow onto boiler using screws provided (I)
- Offer flue pipes to elbow, note that pipe (B) should be inside pipe (A) before connection. Push pipe (B) into inner elbow socket and connect pipe (A) with collar (D). Locking clips (E) are used to lock collar into position.
- Parts (F) and (G) are used to seal brickwork gaps if required. If using part (G) to seal inner wall, this should be placed over flue before installation.

Calculation of flue cutting lengths

- Measure wall thickness **e** (mm)
- For side flues, measure distance from inside face of the side wall to the centre line of the boiler and subtract 205 mm to get dimension **a** (mm) see **diagram 10**.
- Refer to **table 1** for the cutting lengths of both the inner and outer flue pipes for each of the various flue options available.
- **Important:** All flue cutting lengths must be measured from the terminal end of the flue pipes, see **diagram 11**.
- When the dimension **x** measured on site is greater than that given in **table 1** a flue extension kit will be required, refer to **table 2** for details.

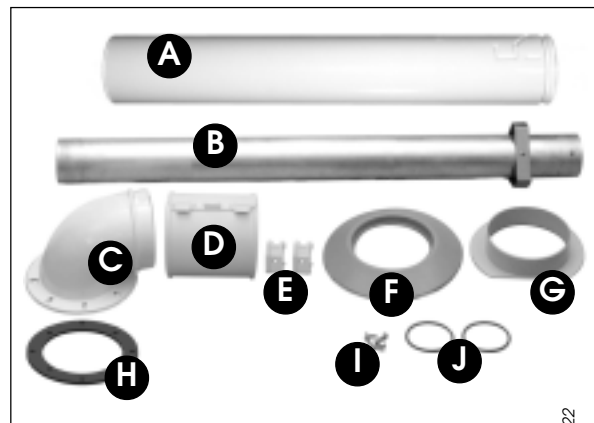

Diagram 9

The flue kit 86285 is 1000 mm long and comprises:

- Outer pipe A
- Inner pipe B
- Flue elbow C
- Fixing collar D
- Locking clips E
- External rubber sealing collar F
- Internal flange G
- Gasket H
- Screws I
- 'O' rings J

Pho 422

Table 1
Flue cutting lengths

Flue option	Cutting length (mm)		Comments
	outer pipe	inner pipe	
Top outlet rear flue	e + 144	e + 224	maximum wall thickness "e" without extension 511 mm

Table 2
Number of extension kits required

Flue option	Dimension 'X'	No. of extension kits
Side flue (left or right)	745 to 1745 mm	1
	1527 to 2745 mm	2

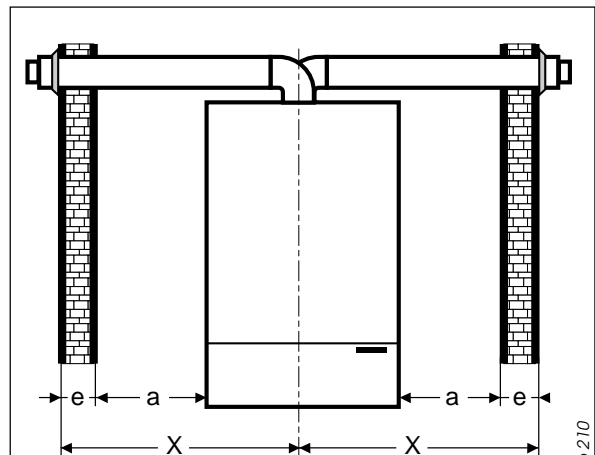

Diagram 10

Hab 210

Maximum horizontal flue run 3m

For each 90° flue bend fitted, reduce overall flue length by 1 m.

For each 45° flue bend fitted, reduce overall flue length by 0.5 m.

Horizontal flue kit	86285
Flue extension kit	85091
90° bend kit	85092
45° bend kit	85093

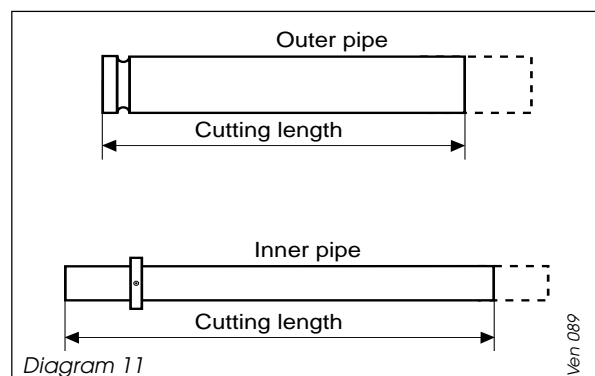

Diagram 11

Ven 089

INSTALLATION INSTRUCTIONS

VERTICAL FLUE INSTALLATION

- A Gasket
- B Vertical adaptor
- C 'O' ring
- D Collar
- E Clamp
- F Screws
- G Terminal
- H Screws

- Fit gasket (C) onto underside of vertical adaptor (B).
- Carefully insert 'O' ring (A) into vertical adaptor inner spigot.
- Fit adaptor correctly onto fan outlet.
- **For flat roof installation**, fit flat roof flashing collar (part no. **85107**)
- Fit flue terminal (L) onto roof ensuring flashing makes a watertight joint.
- **For pitch roof installation**, fit pitch roof flashing collar (part no. **85105**)
- Fit flue terminal (G) onto roof ensuring flashing makes a watertight joint.

NOTE: Maximum vertical height with no bends is 4 m.

Note: Should it be necessary to cut the flue, always cut equal amounts from both inner and outer pipes.

Maximum vertical flue run 11.5m

For each 90° flue bend fitted, reduce overall flue height by 1 m.

For each 45° flue bend fitted, reduce overall flue height by 0.5 m.

Vertical flue terminal (Black) 85103

Pitched roof flashing 85105

Flat roof flashing 85107

Flue extension pipe 85099

90° bend kit 85101

45° bend kit 85102



Diagram 12

INSTALLATION INSTRUCTIONS

ELECTRICAL CONNECTION

Warning: This boiler must be earthed.

All system components must be of an approved type.

Connection of the whole electrical system and any heating system controls to the electrical supply must be through a common isolator.

Isolation should preferably be by a double pole switched fuse spur box having a minimum contact separation of 3 mm on each pole. The fused spur box should be readily accessible and preferably adjacent to the boiler. It should be identified as to its use.

A fused three pin plug and shuttered socket outlet may be used instead of the fused spur box, provided that:

- They are not used in a room containing a bath or shower.
- Both the plug and socket comply with the current issue of BS1363.

The mains electrical supply must be maintained at all times in order to provide domestic hot water and frost protection

Note: For further information, see The Building Regulations 1991 - Conservation of fuel and power - 1995 edition - Appendix G, table 4b.

DO NOT INTERRUPT THE MAINS SUPPLY TO THE BOILER WITH A TIME SWITCH OR PROGRAMMER.

The **combitek F 23 E** is delivered with 1 metre mains supply lead ready connected.

External controls

The boiler will work for heating **AS DELIVERED** without a room thermostat fitted provided the two wires on the integral external controls connection **REMAIN LINKED TOGETHER** (as supplied).

If a room thermostat is required, it must be connected as shown below and the link must be removed.

ANY ROOM THERMOSTAT USED MUST BE OF THE VOLTAGE FREE TYPE.

WARNING: ON NO ACCOUNT MUST ANY ELECTRICAL VOLTAGE BE APPLIED TO EITHER OF THE TERMINALS OF THE EXTERNAL CONTROLS CONNECTION

WARNING: This boiler must be wired in accordance with these instructions. Any fault arising from incorrect wiring cannot be put right under the terms of the guarantee.

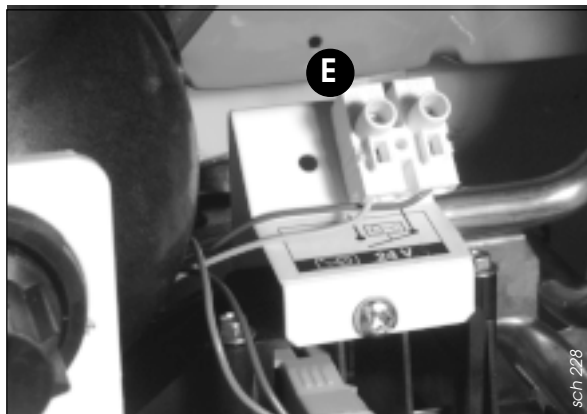

When fitting an external control, remove wire link (E) and connect voltage free thermostat as shown

For no external controls leave wire link (E) in place

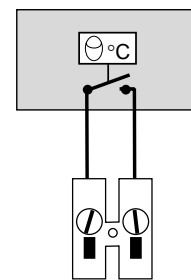
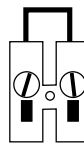

sch 229

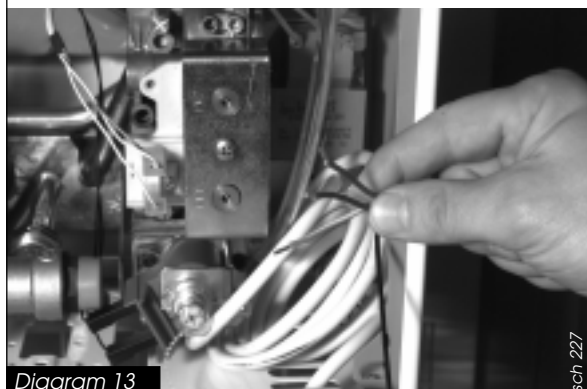

The mains electrical cable is supplied with the boiler. It is coiled and tucked inside the boiler

INSTALLATION INSTRUCTIONS

COMMISSIONING

The commissioning and first firing of the boiler must only be done by a competent person.

Gas installation

It is recommended that any air is purged from the supply at the gas inlet test point on the left hand side of the gas valve, **see diagram 14**.

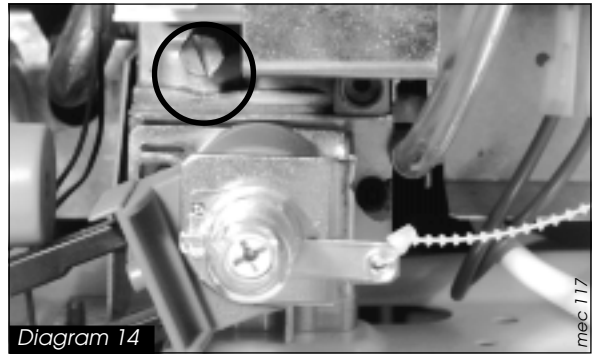

Filling the system

1 Open isolating coks to boiler (see diagram 7a)

3 Open the tap on the system filling loop and fill the system until the pressure indicated on the display is between 1 and 2 bar.



Sec 058

2 Undo, but do not remove, cap on automatic air vent on top of pump. Do not re-tighten cap.



Reg 008

4 Bleed each radiator until a continuous jet of water is obtained.



Ins 061

5 Open various hot water taps to bleed system.



Ins 062

6 Make sure that pressure gauge reads between 1 and 2 bar. Re-pressurise system as necessary.



Sec 058

Important:

- If this procedure is not carried out properly, the boiler will go into safety lock-out until all of the air has been purged.
- When venting air from boiler, do not touch the schrader valve on the expansion vessel, it is NOT a vent.
- Before starting the boiler, turn the pump impellor to make sure it is free to move.
 - Unscrew black cap on front of pump.
 - Using screwdriver, push in pump spindle and turn pump impellor 3 to 4 times. DO NOT HIT SPINDLE. Replace black cap.

Starting the boiler

Before starting the boiler check that:

- The gas meter tap is open. If using Butane or Propane, check that valve on storage cylinder or tank is open.
- You have removed the two fan transit clips from fan.

- The boiler gas service cock is open.
- The boiler is connected to the electrical supply and switched on.
- The front casing is fitted.

First starting up

- Following the instructions given in the 'User Instructions' set boiler to run in central heating mode.
- Set boiler thermostat for maximum temperature ensure timeclock is "ON" and check that any external controls, if fitted, are calling for heat.
- Allow the temperature to rise to the maximum value, with all radiator valves open. The temperature rise will cause release of the gases contained in the water of central heating system.
 - Gases driven towards the boiler will be automatically released through the automatic air vents.
 - Gases trapped at the highest point of the system must be released by bleeding the radiators.

INSTALLATION INSTRUCTIONS

ADJUSTMENTS

On reaching maximum temperature, the boiler should be turned off and the system drained as rapidly as possible whilst still hot.

- Refill system to a pressure of 1.5 bar and vent as before.
- Restart boiler and operate until a maximum temperature is reached. Shut down boiler and vent heating system. If necessary, top up heating system and make sure that a pressure of 1.5 bar is indicated on the pressure gauge when system is COLD.

Gas pressures

The main burner pressure should be checked during commissioning to make sure the correct output is obtained. Proceed as follows:

- Shut down boiler.
- Undo screw on burner pressure test point below sealed combustion chamber and connect a suitable manometer, **see diagram 15**.
- Start boiler as described in 'User Instructions'.
- Set boiler thermostat to maximum and check that any external controls are calling for heat.
- Check that the reading on the gauge matches that given in 'Technical Data' for the type of gas being used.
- Adjust the range rating adjuster screw as necessary to obtain the desired input, **see diagram 16**.
- Shut down boiler.
- Remove manometer, tighten up test point screws and check for gas soundness.
- Using a ball point pen, clearly indicate on the data label the input the boiler is set to.

Note: This adjustment does not affect the domestic hot water output.

If measured burner pressure differs greatly from the given figure, check the gas inlet pressure as follows:

- Shut down boiler.
- Remove screw from inlet test point on the side of the gas valve, **see diagram 14**.

SAFETY DEVICES

Air flow rate safety device

If an obstruction, even partial, of the flue occurs, for any reason whatsoever, the built in safety system of the boiler will turn the boiler OFF and the fan will continue to run.

The boiler will be ready to operate when the fault has been cleared.

In case of power supply failure

The boiler no longer operates.

As soon as power supply is restored, the boiler will be automatically restarted.

Overheat safety

In the event of a problem, the overheat thermostat causes safety shutdown of the boiler. Should this occur, reset the thermostat by pressing the red button. The overheat thermostat is located on the RHS of the heat exchanger.

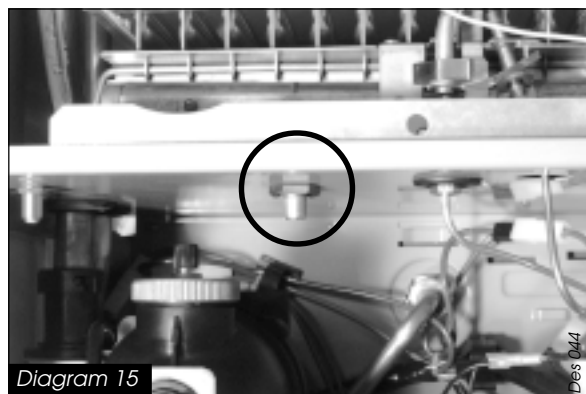

Diagram 15

Des 044

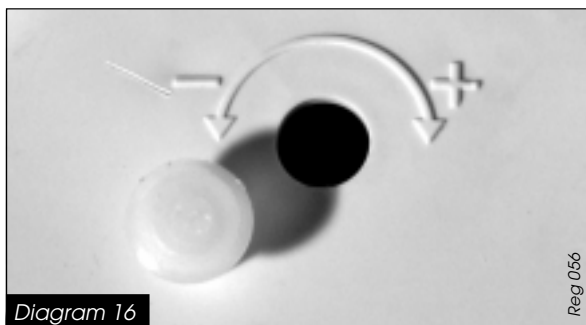

Diagram 16

Reg 056

- Connect a suitable pressure gauge.
- Start boiler as described in 'User Instructions'.
- Check that the inlet pressure reading matches that given in 'Technical Data' for the type of gas being used.
- Shut down boiler.
- Remove pressure gauge, tighten up test point screws and check for gas soundness.
- If the gas pressure is incorrect, refer to the Fault Finding section in 'Servicing Instructions'.
- If the inlet pressure is below that given, the gas supply pipework/meter must be checked and any fault corrected.
- In the case of an LPG installation, check the storage tank or cylinder, regulator and pipework.

Important notice: A central heating system cannot operate satisfactorily unless it is properly filled with water and unless the air initially contained in the piping systems has been properly bled off. If these conditions are not satisfied, air noise will occur within the system.

The **COMBITEK F 23 E** boiler has a built in frost protection device that protects the boiler from freezing. If the boiler is to be left and there is a risk of frost, ensure that the gas and electrical supplies are left connected and the summer/winter switch is in the ❄️ position. The frost protection device will light the boiler when the temperature of the boiler water falls below 6°C. When the temperature reaches 16°C, the boiler stops.

Note: This device works irrespective of any room thermostat setting and only protects the boiler.

INSTALLATION INSTRUCTIONS

SETTINGS

Gas valve setting

All boilers are tested and factory set during manufacture. Should it be necessary to reset a gas valve, for example after replacement, proceed as follows:

- Shut down boiler.
- Connect a suitable pressure gauge as described in 'Commissioning'.

Maximum setting

- Remove one electrical connector from the modulating gas valve coil.
- Turn the domestic hot water temperature adjuster to maximum setting.
- Remove the protective cover from the gas valve adjuster.

Using a 2 mm Ø rod, press in the spindle in the middle of screw.

- Turn nut 'B' to obtain the desired pressure, see technical data.

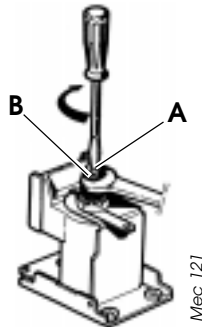

Minimum setting

This must be done AFTER the maximum setting.

- Hold nut 'B' to prevent from turning, turn nut 'A' to obtain the desired pressure, see technical data.

After adjustment, refit the cover to the gas valve adjuster and refit electrical connector.

Bypass

The **COMBITEK F 23 E** has a built-in bypass. This must be adjusted according to the requirements of the system, refer to the flow rate pressure curve (**diagram 3**). The boiler is supplied with the built-in bypass open a half a turn. It is adjusted by turning the bypass screw (**A**), **see diagram 17**. Turn the screw clockwise to close the bypass.

When using thermostatic radiator valves (TRV's), it is recommended that an additional, adjustable bypass of 15 mm minimum diameter is fitted between the flow and return of the heating circuit, **see diagram 6**. Any bypass must be fitted before system controls.

PCB Settings

The combitek has a switch SW1 on the main PCB which incorporates two dip switches. Both these dip switches should normally be set to the Off position.

Purpose of dip switch 1 :

In the Off position the pump will be on and off with the room stat (this is the normal position).

In the On position, the pump will be on and off with the burner.

Purpose of dip switch 2 :

Not used in UK. Leave in off position.

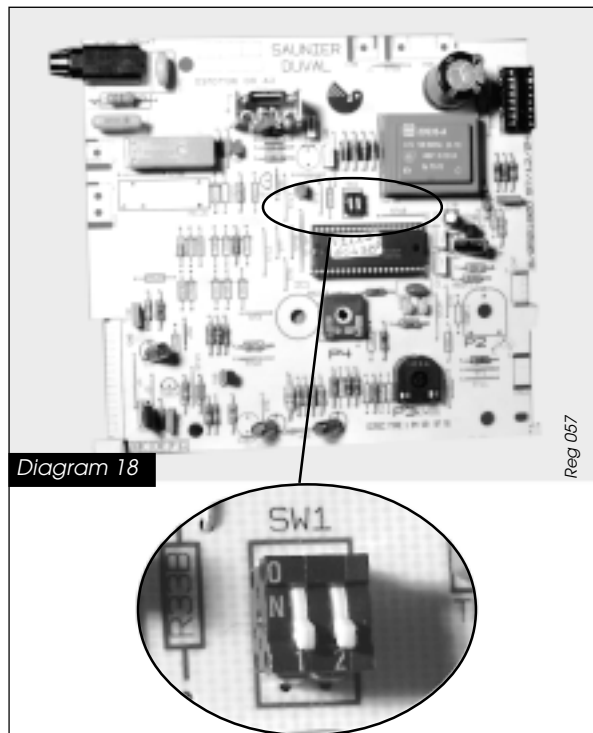
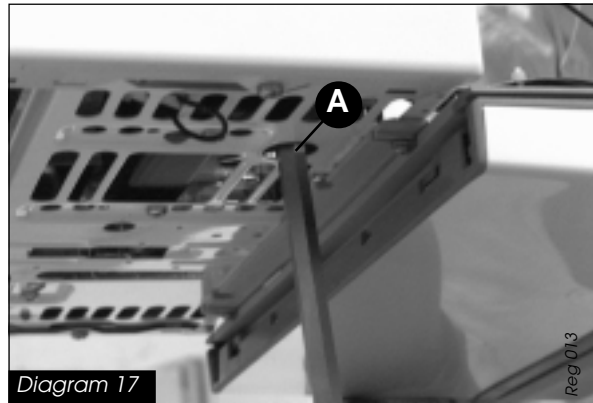

SERVICING INSTRUCTIONS

ROUTINE CLEANING AND INSPECTION

To ensure the continued efficient and safe operation of the boiler it is recommended that it is checked and serviced at regular intervals. The frequency of servicing will depend upon the particular installation conditions and usage, but in general once a year should be enough.

It is the law that any servicing is carried out by a competent person.

Service Check and Preparation.

- Operate boiler and check for any faults that need to be put right.
- Isolate boiler from the gas and electrical supplies.
- On completion check all gas carrying parts for soundness with leak detection fluid.
- The maximum domestic hot water flow rate is 12 litres/minute.
- Remove boiler casing as follows:

Upper front panel

- Disengage the two 'quarter turn' fasteners by turning the heads of the screws a quarter of a turn towards the centre of the boiler.
- Carefully lower the panel down on its hinge until it is horizontal.
- Turn both plastic catches to release upper front panel.
- Remove upper front panel by pulling forward at the bottom and lifting off.

Note: The upper front panel is retained by a plastic safety strap, disengage this before removal.

Side panels

- From below boiler, unscrew and remove black plastic screws securing side panels to the boiler.
- Prise out black plastic inserts and lift panel off boiler.

Combustion chamber

- Loosen two wing nuts on combustion chamber cover.
- Disengage retaining lugs from holes in either side of combustion chamber and move rods away to clear combustion chamber sides, **see diagram 19**.
- Unclip two toggle clips holding upper part of combustion chamber in place.
- Holding both sides, pull chamber forward to release it from underside of heat exchanger and out of boiler.
- Take care not to damage insulation material on inside faces of combustion chamber.

Cleaning the burner

- Pull off leads to ignition electrode.
- Pull off lead to flame sense electrode.
- Unscrew and remove screw holding earth lead to flame sense electrode.
- Undo main gas supply nut from main burner.
- Unscrew and remove locking nut from both main gas connection and burner pressure tapping point.
- Lift front edge of burner until tapping point and gas supply connection are free. Remove burner from boiler taking care to retain both fibre washers and seal on gas supply for use on reassembly.

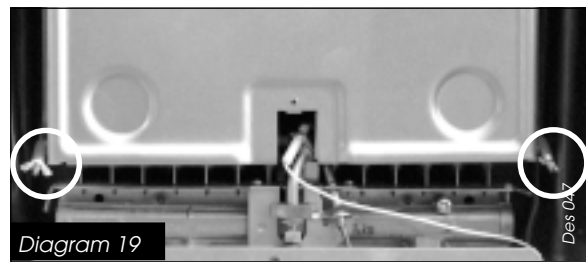

- Unscrew and remove two injector bar retaining screws and separate injector bar from burner.
 - Examine and clean injectors as necessary.
- Note:** Do not use a wire or sharp instrument on the holes.
- Replace burner in reverse order to removal.

Heat exchanger

- After removal of burner, examine heat exchanger for any blockages or build up of deposits.
 - Clean using soft brush or vacuum cleaner.
- Important:** Take care not to scratch or otherwise damage painted surface of heat exchanger.

Reassembly of parts removed for servicing

- Replace all parts in reverse order to removal.

Flue system

- Check externally to make sure flue is not blocked.
- Inspect flue system to make sure all fittings are secure.

Operation of fan

- Switch on electrical supply and turn on gas.
- Switch boiler On/Off switch to 1 (On).
- Light burner by opening a hot tap.
- Without upper front panel in place, burner should be prevented from lighting by air flow detection system.
- Refit upper front panel.
- Check that fan runs when burner is lit and stops when it goes out.

Cold water inlet filter

- Drain down hot water circuit of boiler as follows:
- Close isolating valve on cold water inlet connection, **see diagram 5**.
- Open one or more hot water taps to drain boiler.
- Undo connecting nut from cold water inlet connection to gain access to filter.
- Remove restrictor, then filter from cold water inlet connection.
- Clean and inspect filter, replace if necessary.
- With both flow restrictor and filter in place, reconnect pipe to inlet connection and tighten.
- Fully open isolating cock on cold water inlet connection and check for leaks.

Operation of water valve

- With the Summer/Winter control in the 'Summer' position, slowly open a convenient tap until boiler lights.
- Measure water flow, it should not be greater than 3,5 litres/minute.
- If necessary, replace diaphragm.
- Replace all outer panels.

SERVICING INSTRUCTIONS

REPLACEMENT OF PARTS

To replace microswitch assembly

- Disconnect microswitch by pulling off plug.
- Unclip external controls connector from mounting bracket.
- Undo two screws securing microswitch assembly to reversing valve assembly, **see diagram 20**.
- Remove microswitch assembly from reversing valve.
- Fit replacement microswitch assembly in reverse order to removal.
- Reconnect plug and refit external controls connection to bracket.

To replace fan

- Disconnect power supply and earth leads to fan.
- Unscrew and remove two fan retaining screws located at front edge of fan mounting plate.
- Remove fan with mounting plate attached by pulling forwards and out of boiler.
- Unscrew and remove three screws securing fan to fan mounting plate.
- Fit replacement fan to mounting plate and secure with screws.
- Fit replacement fan to boiler in reverse order to removal making sure that mounting plate retaining lugs are properly engaged into flue hood.
- Reconnect power supply and earth leads.

Important: Make sure that fan outlet is correctly fitted into the flue elbow at the top of the boiler. Before commissioning boiler, remove the two plastic transit clips from replacement fan.

To replace air pressure switch

- Locate air pressure switch in upper left hand corner of sealed chamber.
- Pull off plastic tube from left hand connection.
- Grasp pressure switch and disengage it from bracket clips by pulling from the top.
- Remove electrical connections from switch.
- Fit electrical connections to terminals 1 and 3 of replacement switch.
- Fit replacement switch in reverse order to removal.

Important: Refit plastic tube to LEFT hand connector (marked P1).

To replace spark generator

- Locate spark generator on bracket to right hand side of gas valve.
- Undo and remove screw securing lower terminal cover to bracket and remove bracket.
- Disconnect four leads from spark generator.
- Undo and remove screw securing spark generator to bracket and remove spark generator.
- Fit replacement spark generator in reverse order to removal.
- Reconnect two grey power supply leads and two clear ignition leads to spark generator, the polarity is not important.
- Refit lower terminal cover.

To replace main printed circuit board (PCB)

- With lower front panel down as described previously, undo and remove screw holding pump con-

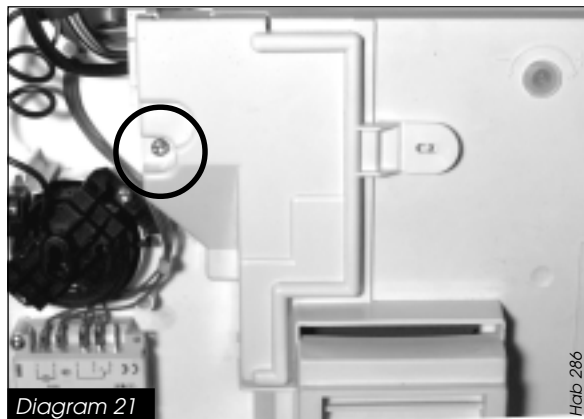
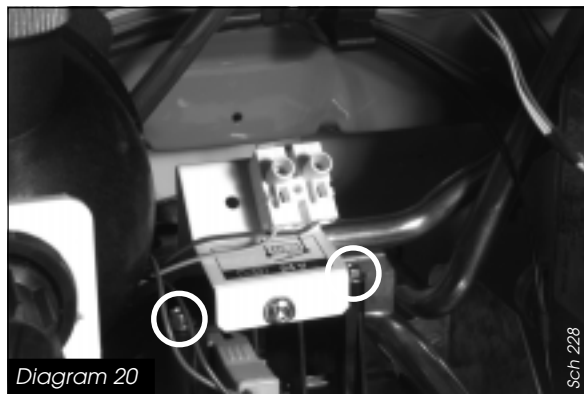

nection cover to PCB cover, **see diagram 21**.

- Open cover and unclip plastic clip securing pump cable to lower front panel.
 - Pull off pump connector and earth lead.
 - Undo and remove four screws securing PCB cover to lower front panel.
 - Lift off PCB cover.
 - Pull off connectors CN6, CN7, CN8 and CN9 on PCB.
 - Undo and remove screw holding PCB to lower front panel.
 - Lifting PCB up slightly on LHS, pull PCB out of electrical connector on ignition PCB. Leave ignition PCB in place.
 - Fit replacement PCB in reverse order to removal.
- Important:** When fitting replacement PCB, ensure that control knob spindle correctly locates into PCB adjuster slots.
- Refit connectors and covers in reverse order to removal.

To replace ignition PCB

- Gain access to PCB's as described in previous section.
- Remove main PCB securing screw as described in previous section.
- Pull off three electrical connectors on PCB.
- Lift up ignition PCB, separate from main PCB and remove from boiler.
- Fit replacement PCB in reverse order to removal.
- Refit connectors and covers in reverse order to removal.

To replace pump

- Drain down heating circuit of boiler only as follows:

SERVICING INSTRUCTIONS

- Close isolating valves on flow and return connections.

It is not necessary to drain entire heating circuit to carry out this work.

• Gain access to pump connection as described in **'To replace main PCB'**.

- Pull off pump connector and earth lead.
- Pull out retaining clip from telescopic pump outlet connection and slide connection upwards to release from pump.
- Undo and remove two fixing screws and remove pump retaining bracket from front of pump.
- Grasp pump body, lift upward to disengage from reversing valve and turn pump to right. Remove pump by pulling forward and over reversing valve assembly.
- Discard old pump inlet 'O' ring.
- Apply silicone grease to new 'O' ring supplied, and fit onto inlet connection on replacement pump.
- Fit replacement pump in reverse order to removal.

Note: Apply silicone grease to pump outlet connection 'O' ring before assembly.

- Refit pump electrical connection.
- Open isolating valves on flow and return connections, refill, vent and pressurise boiler. Check for leaks.

To replace pressure gauge

- Drain down heating circuit of boiler only as described in **'To replace pump'**.
- Undo and remove screw securing pressure gauge capillary to front section, **see diagram 22**.
- Carefully pull capillary from front section.
- Undo and remove two screws securing pressure gauge to lower front panel and remove gauge.
- Fit replacement gauge in reverse order to removal.
- Fit capillary of new gauge to front section using new 'O' ring supplied.
- Open isolating valves on flow and return connections, refill, vent and pressurise boiler. Check for leaks.

To replace reversing valve assembly

- Remove pressure gauge capillary as described previously.
- Remove pump as described previously.
- Remove microswitch assembly as described previously.
- Remove retaining clip from LHS pipe connection on front section of valve and disengage pipe.
- Unscrew and disconnect heating flow (centre) connection at fixing jig.
- Remove retaining clip from heating flow pipe connection on right of front section.
- Remove flow pipe from boiler.
- Unscrew and disconnect heating return (left hand) connection at fixing jig.
- Remove retaining clip from expansion vessel pipe connection at rear of reversing valve assembly and disengage pipe, pushing pipe back and out of reversing valve.
- Undo and remove large screw holding water valve to back plate of reversing valve assembly, **see diagram 23**

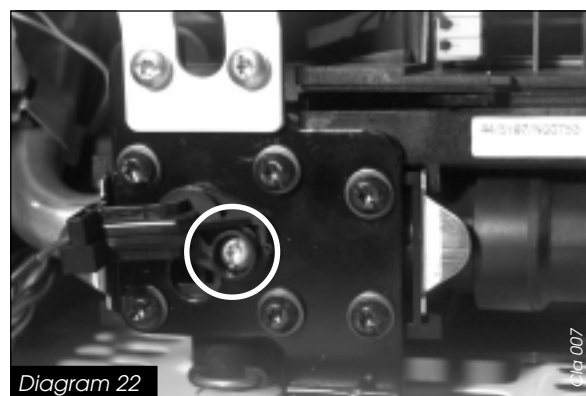

Diagram 22



Diagram 23

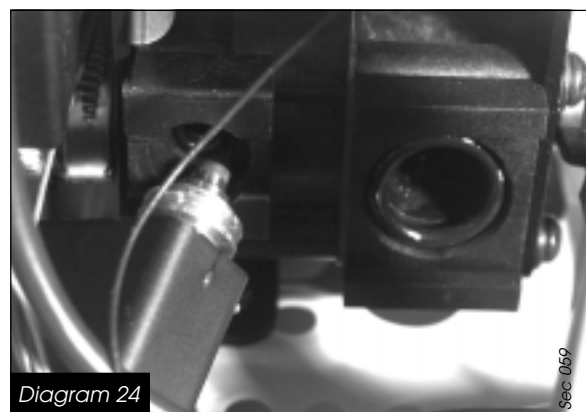

Diagram 24

- Push water valve back to disengage it from reversing valve.
- Unclip and remove loss of water pressure switch from left of reversing valve assembly, **see diagram 24**.
- From below boiler, undo and remove three screws holding reversing valve to bottom plate of boiler. Remove complete reversing valve assembly from boiler.
- Undo and remove heating return connecting pipe and hose from rear of reversing valve assembly. Fit hose to replacement reversing valve assembly.
- Fit replacement reversing valve into boiler in reverse order to removal.
- Note:** Use new 'O' rings, retaining clip, filter and washer provided.
- Unscrew and remove microswitch assembly from top of replacement reversing valve assembly to allow refitting of water valve.

SERVICING INSTRUCTIONS

Note: fit expansion vessel pipe and loss of water switch to reversing valve assembly before pump, to ensure that it is correctly located. Apply silicone grease to all 'O' rings and hoses prior to assembly.

- Open isolating valves on flow and return connections, refill, vent and pressurise boiler. Check for leaks.

To replace reversing valve front section

- Remove pressure gauge capillary as described previously.
- Remove pipe connections from either side of reversing valve front section, refer to previous section.
- Move short selector lever on front of valve to left hand position.
- From below boiler, undo and remove single screw holding reversing valve front plate to bottom plate of boiler.
- Undo and remove six screws holding front section to rear section of reversing valve, **see diagram 25**.
- Remove front plate complete with pump bracket and then front section from reversing valve, along with rubber sealing gasket.
- Assemble bypass valve provided and fit into hole in underside of replacement front section. Fit 'U' shaped retaining clip.

Note: Use bypass valve fitted to original front section for guidance.

- Fit replacement front section, with gasket, to rear section.
- Locate front plate and replace six fixing screws. Take care to evenly tighten screws ensuring they are not cross threaded.
- Refit pipe connections to either side of front section using new 'O' rings provided. Apply silicone grease to 'O' rings before fitting.
- Refit pressure gauge capillary in reverse order to removal.
- Ensure short selector lever on front of valve is set to right hand position.
- Open isolating valves on flow and return connections, refill, vent and pressurise boiler. Check for leaks.

To replace loss of water switch

- Drain down heating circuit of boiler only as described in 'To replace pump'.

Note: It is not necessary to drain entire heating circuit to carry out this work.

- Pinch plastic cover to release retaining clips and remove cover from switch. Pull plug lead from switch terminals.
- Remove clip holding switch into left side of reversing valve assembly.
- Pull switch out of reversing valve assembly, **see diagram 24**.
- Fit replacement switch in reverse order to removal, using new 'O' ring provided and applying silicone grease to 'O' ring before fitting.
- Reconnect plug to switch terminals.
- Open isolating valves on flow and return connections, refill, vent and pressurise boiler. Check for leaks.



To replace water valve or diaphragm

- Drain down hot water circuit of boiler only as described in 'Routine Cleaning and Inspection'.
- Remove microswitch assembly as described previously.
- Remove clip holding connecting pipe in rear of water valve. From below boiler, grip clip with long nosed pliers and pull down.
- Using long nosed pliers, slide pipe away from water valve into brass cold water inlet connection.
- Remove clip holding pipe to heat exchanger in rear of water valve. From front of boiler, gripclip with long nosed pliers and pull upwards.
- Unscrew and remove large screw holding water valve to back plate of reversing valve assembly, **see diagram 23**.
- Disengage water valve from reversing valve and remove from boiler.

Note: When disengaging water valve from heat exchanger pipe, check that non-return valve is not held on end of pipe. If so, carefully separate pipe from valve to ensure that small spring and plunger do not fly out and are lost.

- To replace diaphragm, undo five screws and separate main components of water valve.
- If white diaphragm cover is to be replaced, separate original from water valve end casting and fit replacement cover.
- Fit replacement diaphragm, making sure that metal disc FACES diaphragm cover and beaded edge of diaphragm is correctly fitted in corresponding groove in both cover and plastic housing, **see diagram 26**.

- Reassemble water valve, evenly tightening five screws.
- Fit water valve actuating pin into hole in diaphragm cover, through nose end of valve and push in until flush, or slightly below, nose end of valve.

Note: Apply silicone grease to pin before fitting.

- Refit water valve to boiler, locating nose end into rear of reversing valve assembly, 'springing' heat exchanger pipe to gain clearance as necessary. Fit large water valve retaining screw but do not tighten fully at this stage.
- Apply silicone grease to 'O' ring and fit onto end of heat exchanger pipe. Fit pipe into water valve by pulling it forward. Make sure that 'O' ring is correctly located.
- Whilst holding pipe in rear of water valve, fit retaining clip. This should easily clip over pipe and

SERVICING INSTRUCTIONS

should NOT have to be forced. If resistance is experienced, either pipe is not correctly fitted in rear of water valve or clip is not being fitted properly through slot between back plate and plastic housing of water valve. When clip is fitted, check connection by pushing pipe back away from water valve.

- Refit telescopic connecting pipe to inlet of water valve after applying silicone grease to 'O' ring. Fit retaining clip into groove on connecting pipe, through slot between back plate and water valve plastic housing. Check connection by pulling pipe. Make sure that clip is not loose and likely to fall out at a later date. If in doubt, fit a new clip.
- Replace microswitch assembly.
- Open isolating valve on cold water inlet connection and check for leaks.

To replace gas valve

- Ensure gas supply is off.
- Disconnect two black electrical leads from gas valve modulating coil.
- Disconnect two white and one red lead from gas valve main solenoid.
- Pull off clear plastic tube from gas valve to sealed chamber tapping point.
- Unscrew main gas supply pipe nut on top of gas valve, releasing spark ignition unit bracket, **see diagram 27**.
- From below boiler, unscrew gas valve connection between gas valve and isolating cock.
- Unscrew and remove two screws securing gas valve to bottom plate of boiler.
- Remove gas valve from boiler.
- Refit replacement gas valve in reverse order to removal.

Note: Use new 'O' ring provided between gas valve and burner supply pipe.

- Refit electrical connections to replacement gas valve as follows:
 - BLACK leads to modulating coil.
 - WHITE leads to EV1 and EV2 terminals of main solenoid
 - RED lead to COM terminal of main solenoid.

To replace modulating coil

- Ensure gas supply is off.
- Disconnect two black electrical leads from gas valve modulating coil.
- Unscrew and remove two screws holding modulating coil to gas valve and remove coil from gas valve.
- Fit replacement modulating coil in reverse order to removal.
- Reconnect electrical leads to replacement coil.

Note: All boilers are tested and factory set during manufacture. Should it be necessary to reset a gas valve, for example after replacement, refer to '**Settings**'.

To replace safety valve

- Drain down heating circuit of boiler only using drain point on front of non-return valve (located to the right of reversing valve).
- Disconnect safety valve discharge pipe from safety valve.

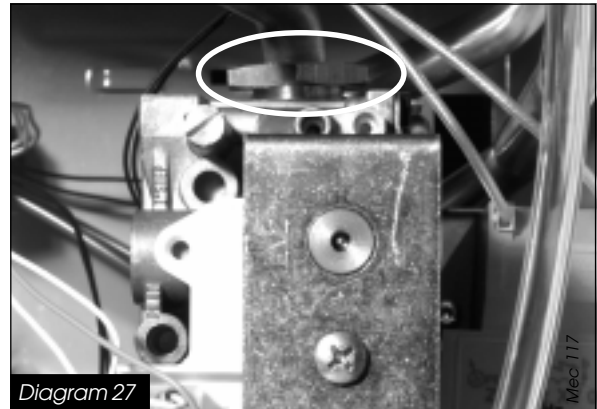
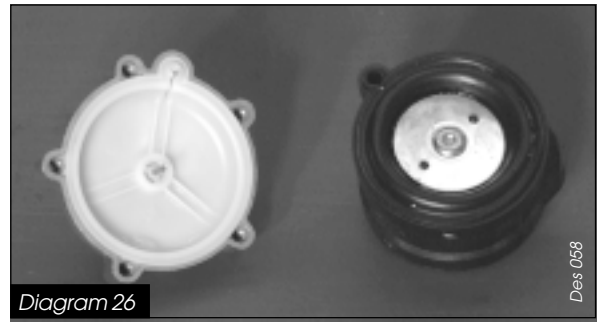

- Pull out clips securing safety valve to non-return valve.
- Remove safety valve from boiler
- Fit replacement safety valve in reverse order to removal.

Note: Apply silicone grease to 'O' ring before fitting safety valve into non-return valve body.

- Refill boiler, vent and pressurise as described previously.

To replace heat exchanger

- Drain down both heating and hot water circuits of boiler only as described previously.

Note: It is not necessary to drain entire heating system to carry out this work.

- Remove combustion chamber cover as described in '**Routine Cleaning and Inspection**'.
- Remove two clips from heating connections to left side of heat exchanger.
- Remove clip holding pump outlet connection into pump and slide connection up pump outlet pipe. Pull complete pipe down to disengage from heat exchanger.
- Remove retaining clip from LHS pipe connection on front section of valve and disengage pipe.
- Disengage pipe downwards from heat exchanger.
- Unscrew and disconnect two hot water connections to right side of heat exchanger.
- Grasp both sides of heat exchanger and slide forwards and out of boiler.
- Fit replacement heat exchanger in reverse order to removal.

Note: Use new sealing washers and 'O' rings provided.

- Open isolating valves on flow and return connections, refill, vent and pressurise boiler. Check for leaks.

SERVICING INSTRUCTIONS

To replace expansion vessel

1 Boiler in place

Note: The expansion vessel can be replaced with the boiler in place provided that there is a minimum clearance of 400mm on one side of the boiler and that no vertical pipework passes between boiler and wall on that side.

• Drain down the heating circuit of the boiler only as described in '**To replace pump**'.

Note: It is not necessary to drain entire heating system to carry out this work.

- Remove pump from boiler as described previously.
- Unscrew pipe connection nut from expansion vessel and disengage pipe from connection. Keep sealing washer.
- Whilst supporting weight of vessel, push bottom of vessel away from boiler, disengaging threaded connection from hole in rear of boiler. Allow vessel to drop out of its two upper retaining brackets.
- Remove vessel to side of boiler.
- Fit replacement expansion vessel in reverse order to removal ensuring that sealing washer is fitted to vessel pipe connection.
- Check that vessel charge pressure is 1bar. Correct if necessary.
- Open isolating valves on flow and return connections, refill, vent and pressurise boiler. Check for leaks.

2 Boiler removed from wall

• Drain down the heating circuit of the boiler only as described in '**To replace pump**'.

Note: It is not necessary to drain entire heating system to carry out this work.

- Ensure that gas and electrical supplies to boiler are turned off.
- Disconnect flue from either rear or top of boiler as applicable.
- Disconnect external controls connections, if applicable.
- Unscrew and disconnect five connections between fixing jig and boiler.
- Disengage pipe connections. Lift boiler off hanging bracket and place on a convenient working surface.
- Remove expansion vessel from boiler as described in previous section.
- Fit replacement vessel in reverse order to removal and check charge pressure.
- Replace boiler on wall, tighten all connections, gas connection first, ensuring that all sealing washers, filters and the cold water flow regulator are fitted before tightening.
- Reconnect flue system.
- Open isolating valves on flow and return connections, refill, vent and pressurise boiler. Check for leaks.
- Reconnect external controls connections, if applicable.
- Reconnect gas and electrical supplies to boiler.
- Check for gas soundness.

To replace boiler thermistor

- Locate boiler thermistor on heating flow pipe on

left hand side of boiler, **see diagram 28**.

- Unclip thermistor from pipe.
- Pull off electrical connections from thermistor.
- Fit replacement thermistor in reverse order to removal.

Note: No heat sink compound is required. The polarity of the connections is not important.

To replace overheat thermostat

- Locate the overheat thermostat on the right hand side of the heat exchanger.
- Pull off the electrical connections from the thermostat.
- Unscrew and remove two screws holding thermostat to heat exchanger.
- Fit replacement thermostat in reverse order to removal, using heat sink compound on the contact surface of thermostat.
- Refit electrical leads, the polarity is not important.

To replace combustion chamber insulation

Front section

- Remove combustion chamber from boiler as described in '**Routine Cleaning and Inspection**'.
- Slide side panels out of combustion chamber sides.
- Lift front insulation panel free from retaining lugs and away from cover.
- Fit replacement panels in reverse order to removal.

Rear panel

- Remove burner from boiler as described in '**Routine Cleaning and Inspection**'.
- Remove clip from base of insulation panel.
- Pull bottom edge of insulation panel forward, downward and out from behind heat exchanger.
- Fit replacement panel in reverse order to removal.
- Replace burner into boiler in reverse order to removal.

To replace ignition electrode

- Remove combustion chamber from boiler as described in '**Routine Cleaning and Inspection**'.
- Pull off ignition leads from ignition electrode.
- Unscrew and remove two screws holding ignition electrode onto burner.
- Fit replacement ignition electrode in reverse order to removal.
- Refit ignition leads, the polarity is not important.



Diagram 28

SERVICING INSTRUCTIONS

To replace flame sense electrode

- Remove combustion chamber from boiler as described in '**Routine Cleaning and Inspection**'.
- Pull off lead from flame sense electrode.
- Unscrew and remove screw holding earth lead to flame sense electrode.
- Unscrew and remove screw holding flame sense electrode onto burner.
- Fit replacement flame sense electrode in reverse order to removal.
- Refit lead.

To replace burner

- Pull off ignition and flame sense leads from electrodes.
- Remove burner from boiler as described in '**Routine Cleaning and Inspection**'.
- Remove ignition and flame sense electrodes as described in previous sections.
- Unscrew and remove two screws holding burner injector bar to burner and remove injector bar.
- Assemble replacement burner, supplied in parts, as follows:
 - Fit burner injectors to injector bar and tighten.
 - Assemble burner elements (14) into front and rear burner supports with securing pins and rods, using original burner for guidance.
 - Fit burner injector bar to burner.
 - Fit ignition and flame sense electrodes to burner.
 - Fit replacement burner to boiler in reverse order to removal.

- Reconnect ignition and flame sense leads to electrodes. Reconnect earth lead to flame sense electrode. The polarity of the ignition leads is not important.

To replace burner injectors

- Remove burner as described previously.
- Remove ignition and flame sense electrodes as described in previous sections.
- Unscrew and remove two screws holding burner injector bar to burner and remove injector bar.
- Unscrew and remove burner injectors from burner bar.
- Fit replacement injectors to injector bar and tighten.

Note: make sure that injector size, marked on each injector, is the same as that given in '**Technical Data**'.

- Reassemble burner and replace into boiler in reverse order to removal.

To replace timeclock

- Gain access to rear of lower control panel as described in '**Routine Cleaning and Inspection**'.
- Unscrew and remove two screws holding timeclock to lower control panel.
- Remove PCB cover.
- Remove timeclock plug from connection CN7 on main PCB.
- Fit replacement timeclock in reverse order to removal.

SERVICING INSTRUCTIONS

SCHEMATIC WIRING DIAGRAM

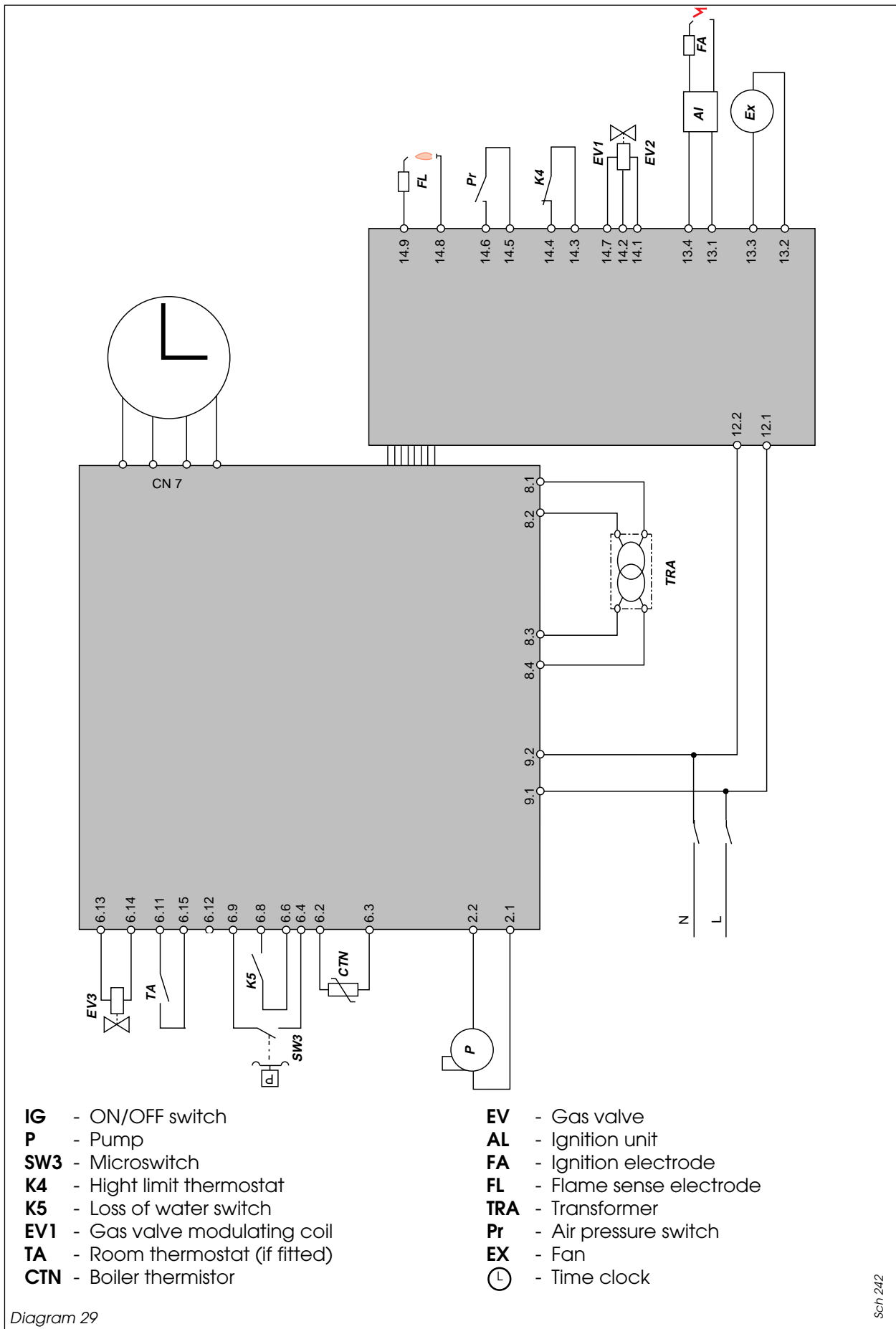

Diagram 29

Sch 242

SERVICING INSTRUCTIONS

FAULT FINDING

Prior to fault finding, check :
 Inlet gas pressure = 20 mbar
 Electrical supply = 240 V - 50 Hz
 Central heating system is pressurised at 1 - 1,5 bar.
 Overheat thermostat on RHS of heat exchanger has not tripped reset if necessary.

Carry out electrical system checks i.e. earth continuity, resistance to earth, short circuit and polarity with a suitable meter.

Note : these must be repeated after any servicing or fault finding. Ensure that all external controls are correctly wired and calling for heat.

The fault finding charts will enable the majority of faults to be diagnosed. To use the charts effectively, it is

necessary to determine exactly which aspects of the boiler are working correctly and which are not.

For example:

If the domestic hot water works but the heating doesn't, refer to **chart No. 1**.

If heating works correctly but the hot water doesn't, refer to **chart No. 2**.

IMPORTANT: Always adopt a logical, step by step procedure starting at the beginning of the appropriate fault finding chart.

WARNING. Always isolate the boiler from the electrical supply before carrying out any electrical replacement work.

Always check for gas soundness after any service work.

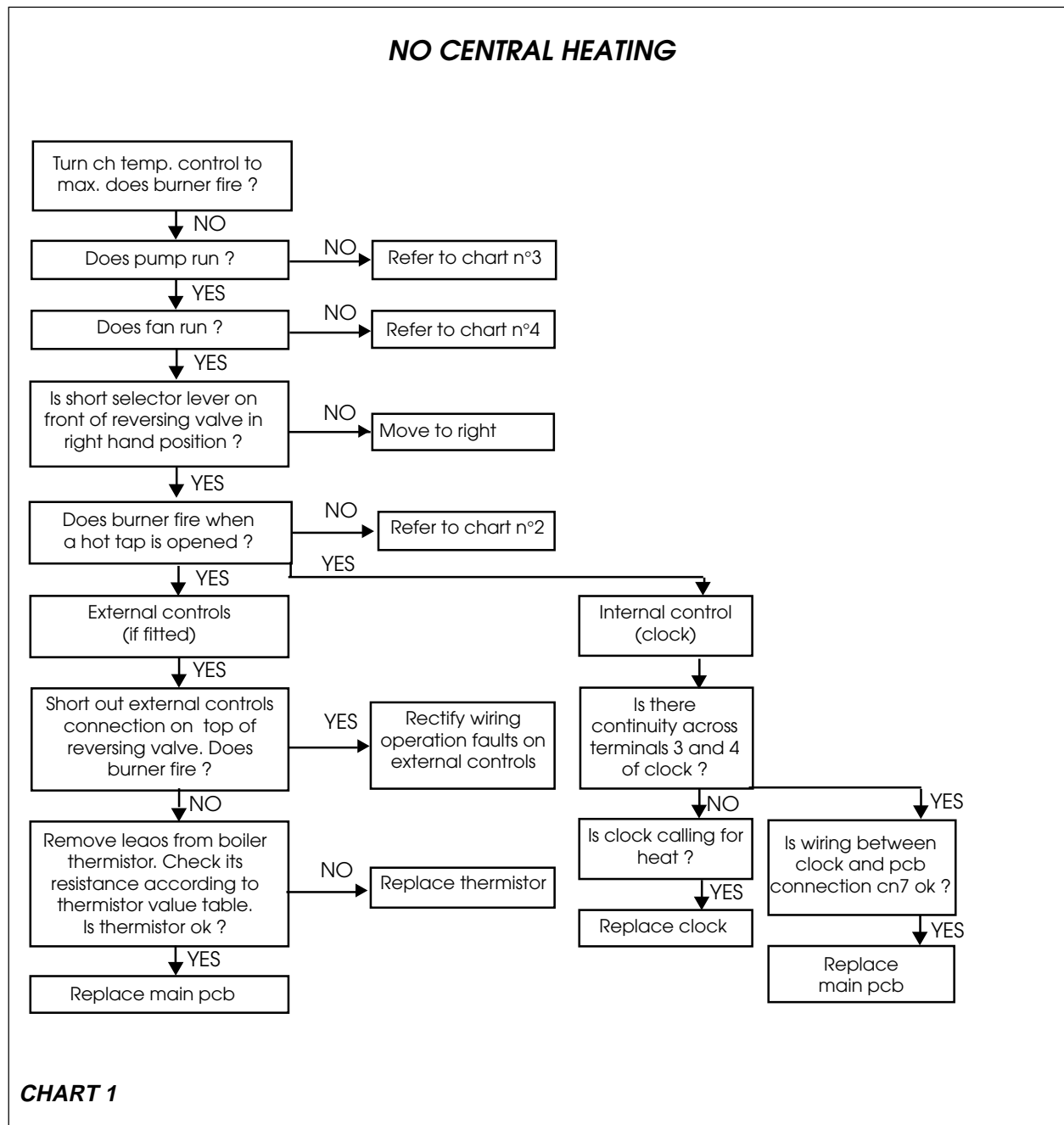

SERVICING INSTRUCTIONS

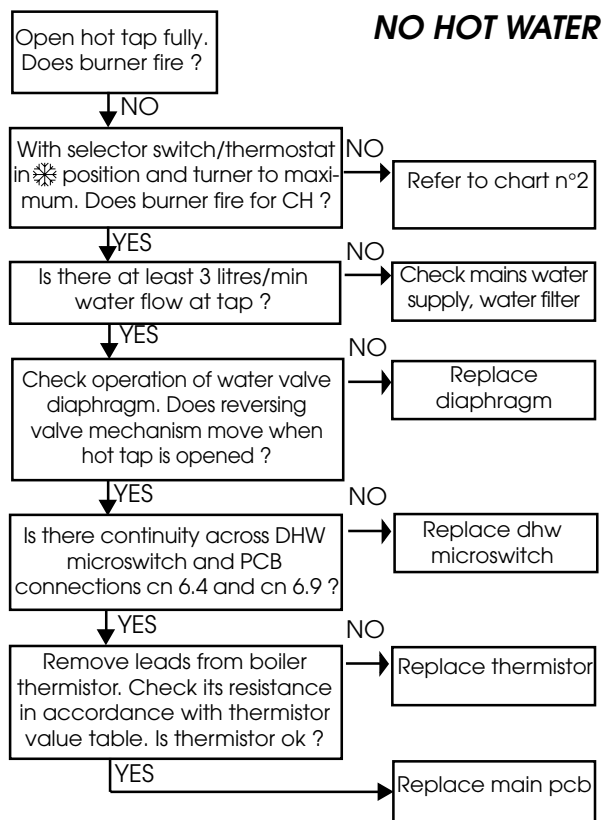

CHART 2

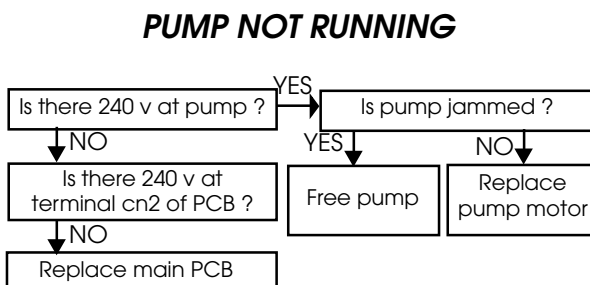

CHART 3

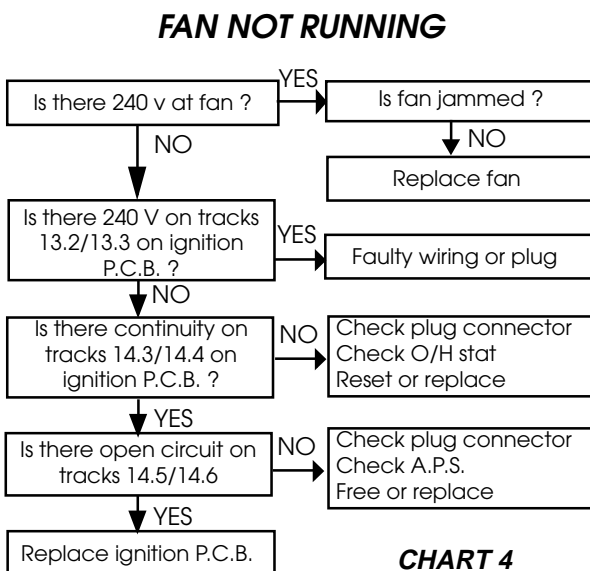

CHART 4

Termistor Values



Temperature (°C)	0	5	10	15	20	25	30	35	40	45	50
nominal resistance (Ω) for NTC	32565	25345	19875	15700	12500	10000	8060	6535	5330	4370	3605
Temperature (°C)	55	60	65	70	75	80	85	90	95	100	
nominal resistance (Ω) for NTC	2989	2490	2085	1755	1480	1260	1070	920	785	680	

SPARE PARTS

When ordering spare parts, quote the part number and description, stating the appliance model number and serial number from the data badge.

Short parts list

No.	Description	Part No.	No.	Description	Part No.
1	Fan	57059	6	Control PCB	57296
2	Pump	51236	7	Water valve diaphragm kit	52519
3	Spark generator	51110	8	Microswitch assembly	51590
4	Air pressure switch	51692	9	Pr essure gauge	57278
5	Main PCB	57286	10	Boiler Thermistor	57060
			11	Overheat thermostat	51199